



SMICOMPANIES

Smart-Iron Technologies™

Part III Technical

1456 Hwy. 317 South Franklin, LA – USA
Phone: 800-264-9894 Website: www.smicompanies.com

Proven Production Rates

Smart-Iron Technologies™

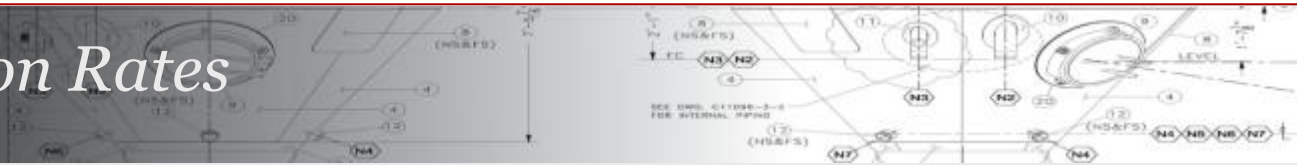

This narrative uses the term “sack of cement” to communicate concepts and express formulas: 1 sack (sk) = 1 CF (Cubic Foot) and 1 CF = 100 lbs. Cements and additives have differing specific gravities that are not being considered here. Factoring all the complexities of the differing specific gravities is exactly what Smart-Iron Technologies does.

These production rates come from running plants that are achieving them on a daily basis with a single blend train.

Material will move at a minimum of 50 sks per minute through the process (Silos to WB, WB to B1, B1 to B2 and B2 to transport (provided line sizes are not reduced on the transport). As a batch leaves the WB to B1 the second batch starts into the WB while the first is blending. This simultaneous operation doubles the rate of material being moved through the plant to 100 sks per minute.

Using the 100 sks per minute number divided by 4 (into WB then B1 then B2 then to truck) $100/4 = 25 \times 60$ you get 1,500 sks per hour and 36,000 sks in 24 hours of continuous production.

The 36,000 sks per day is a pure number and is unachievable. The following considerations must be accounted for:

- **Cycle times** – are the time it takes a blend train vessel to go from 0 PSI to 15 PSI or 15 Hg. Cycle times are approximately 60 to 90 seconds and there are four of them per batch.
- **Cutting in additives** – takes a little training. It’s a two man operation and once the operators become efficient a 20 sk add can be done in 3 to 5 minutes. Most of this work is done while material is moving through the process.
- **Truck scheduling** – is not considered, though it can greatly affect production rates field blend silos can be used to eliminate any delays it may cause.

For loading single air slide transports with 400 sks of blended cement weighing 40,000 lbs.

400 sks @ 25 sks per minute will take 16 minutes

Plus cycle times 6 minutes

Plus cutting additives 5 minutes

27 minutes to load truck

1 truck every 27 minutes = 53 trucks or 21,200 sks per day (24 hours).

For loading twin tank ABT’s with 400 sks of blended cement (200 sks lead & 200 sks tail) weighing 40,000 lbs.

200 sks @ 25 sks per minute will take 8 minutes

Plus cycle times 6 minutes

Plus cutting additives 5 minutes

19 minutes per side $\times 2 = 38$ minutes

1 truck every 38 minutes = 38 trucks or 15,200 sks per day (24 hours).

A couple points worth mentioning are:

- In auto operation batches are written ahead of time or called back from previous jobs and put in queue to run consecutively. The process never stops.
- In auto operation consistent accuracy is assured by the PLC based process controls. Ticket printing is done automatically.

Theory of Operation

Automated Pressure/Vacuum Cement Bulk Plant

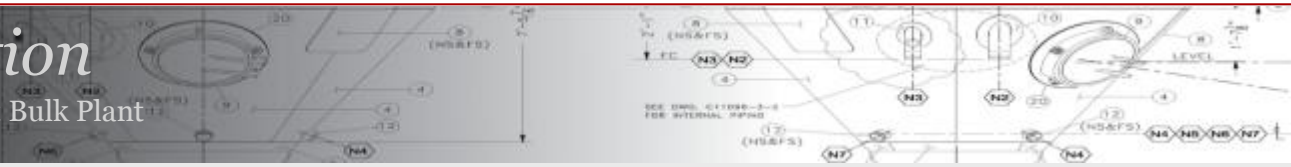

Main ingredients such as Class A, C and H cements are purchased and stored in the silos and dry additive ingredients such as retarders, loss circulation materials and salts are stored in the warehouse in 50 lb. sacks. The PLC weighs and records each silo ingredient purchase and charges the material out to jobs as they are loaded (by volume not by price). Dry additive transactions are weighed and recorded as they are sold (put into the add hopper).

Real time inventory of silo ingredients is displayed at all times (eliminating the need for the dry erase board that is typical in most bulk plants). Silo inventories can be sent to vendors in real time with set point reminders that tell them when to refill.

In Auto mode the process begins by pulling the weigh batcher down to 15Hg. (This is a set point and can be assigned any value.) When it is reached the discharge valve on the appropriate silo is opened and half of the amount of material from the silo is pulled to the weigh batcher. This process is repeated for all silo material in the batch. Once half of all silo ingredients are in the weigh batcher the monitor will prompt you to put in the additives. As each additive is put on the scale its weight and identity is confirmed on the panel view touch screen at the add hopper station. Additives can be sent to the weigh batcher all at once or one at a time.

The Smart-Iron operating system has a safety feature called “vacuum verification”. The add hopper discharge valve will not be allowed to open unless there is vacuum present in the weigh batcher. This safety feature prevents the operator from opening the discharge valve to a pressurized weigh batcher and causing a blow back against a full or partially loaded add hopper.

Once the dry adds are in the process resumes in auto and pulls the second half of the silo ingredients into the weigh batcher. When all ingredients are in the weigh batcher the process shifts from vacuum to pressure and when it reaches 15 PSI the weigh batcher discharge valve is opened and the batch enters the first blender.

As soon as the first batch is out of the weigh batcher it shifts to vacuum again and begins to pull the silo ingredients for the next batch that is in queue.

The first batch will continue to move through blend 1 and blend 2 then it is ready to be loaded into the transport. The process will stop here and the blend 2 graphic on the monitor will flash in red, indicating the batch is ready for loading. With the truck in position, the fill and vent lines are connected and a sample bag is put in place. The final discharge valve is manually opened to load the truck.

Standardization & Visibility

Smart-Iron Technologies™

SMI builds cement bulk plant facilities based upon standard parts designed for optimal performance in their particular part of the overall system. Multiple plant facilities then have major cost benefits with a single maintenance program, operator training program, safety program, common business controls, common operating reports and only one spare parts inventory need. Business controls impacted by Smart-Iron Technologies include:

- Minimal operating crew size. It only takes three personnel to run a Smart-Iron plant.
 - ❖ Reduced worker's compensation insurance and benefits package cost.
 - ❖ Reduced liability and product liability due to consistency of automated processes.
- Improved site safety and environmental exposure (OSHA and regulatory compliance)
- Consistent SOP's (standard operating procedures) applicable to all facilities.
- Consistent operators training for all facilities.
- Standard Maintenance procedures at all facilities.

Visibility comes with internet connectivity. Managers and operators are now integrated into the system. This visibility makes a big difference.

- Visibility allows operators and managers to see the plant's activity remotely, inventory levels, job status, maintenance reports for instance are all visible.
- Visibility holds people accountable for plant maintenance, inventory management and productivity.

Cement Bulk Plant (Problems)

Smart-Iron Technologies™

We are in bulk plants for one reason or another on a regular basis. Here are some of the common problems we encounter:

- Air compressors overheating
- Vacuum pumps damaged by cement dust
- Dust collectors overburdened
- Cement bridging in silos and blenders
- Cement and additives blocking up in piping
- Maintenance is lacking

These problems lead to major equipment damage, down-time, low production rates, inconsistent blending, higher maintenance costs and disappointed customers.

Our Smart-Iron plants are designed to eliminate all of these problems and give you many years of reliable service and consistently reliable results.

If you are experiencing any of these problems or others in your plant, the good news is they're all correctable. Give us a call and we'll schedule a visit to your facility for an assessment. We'll give you a written report on your plant's condition, strengths and weaknesses and our recommendation as to what needs to be done to bring it up to your standards. Best of all this service will not cost you anything!

Automation Solves Problems

Smart-Iron Technologies™

Accurate Ingredient Proportions and Homogenous Blending

Bulk cements and additives have differing specific gravities. These materials range from as little as 20 lbs. per cubic foot to as much as 100 lbs. per cubic foot or more. Because they are in powder form weight is the means used to determine the quantity of each ingredient in a batch and the total batch volume. All sacks don't weigh the same and the math becomes confusing to all but the most skilled operators.

In a manual bulk plant the operator is the quality control point. He is responsible for bringing the right ingredients in the right proportions from the silos and the add hopper to the weigh batcher and processing them through the blend train. He does this by feel and knowing the plant.

SMI's Smart-Iron Software is programmed to know the weight of each ingredient, where it is in the plant and the length of piping between the ingredient source and its destination is calibrated. In Auto mode the process runs with greater precision and speed than any human operator. It automatically prints the shipping documents (with preview option) and records each transaction.

Whether in Manual or Auto mode the software knows the size of all the vessels in the plant and will prevent an operator from running a quantity that is too large by volume into any vessel.

In light of recent events in the GOM oil and gas industry blend consistency and other bulk plant procedures are being paid particular attention by the major oil companies. Just getting the ingredients and proportions right for a given batch does not guarantee a homogenous blend. Inconsistently blended material causes many problems as this incident revealed.

To promote homogenous blending Smart-Iron Software looks at bulk plant ingredients in two ways, main ingredients and additives. Main ingredient totals are split in half while additives (usually only 2 to 5% of a given batch) are taken as a whole. For instance, if a batch calls for 200 sacks of Class H as a main ingredient, 100 sacks would be pulled, the additives brought in and the remaining 100 sacks stacked on top. This layering of ingredients followed by three consecutive vessel to vessel transfers will produce consistent results.

Accurate sampling and lab testing following consistent procedures will insure that your process is dialed in and can be relied upon to produce on-spec, homogenous blends every time. Sampling that is done in multiple small increments throughout the loading process will tend to give favorable lab results but may not catch blending inconsistencies. The best way to obtain true results on blending efficiency is to use a *diverted flow sample catcher* and trend the results taken over several batches. SMI manufactures the diverted flow sample catchers and the *test lab storage units* as part of our Quality Assurance Program for our clients.

Operator Interface - Main Screens

Smart-Iron Technologies™

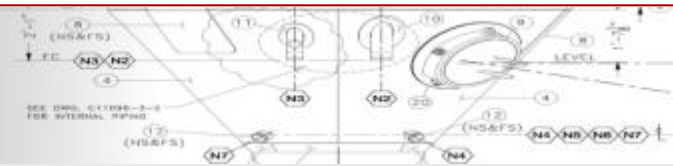

The Smart-Iron operating system has two modes of operation “manual” and “auto”. In either operating mode the process screens, safety features, maintenance bulletins, reports and security settings function the same way and can be set up to your preferences.

During plant operation, two primary screens (below) are in display – left “blend train screen” - right “silos screen”.

All weights and pressures are displayed in real time. The valves are operable from the screens or the push buttons on the desktop in manual mode.

All other screens are available and can be displayed at any time by selecting them from the tool bar menu. Air system status is displayed above the tool bar.

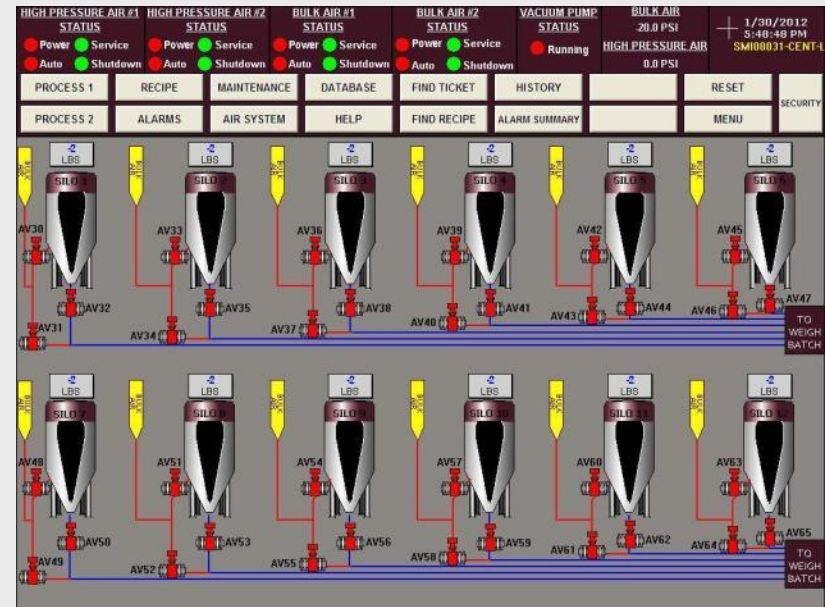
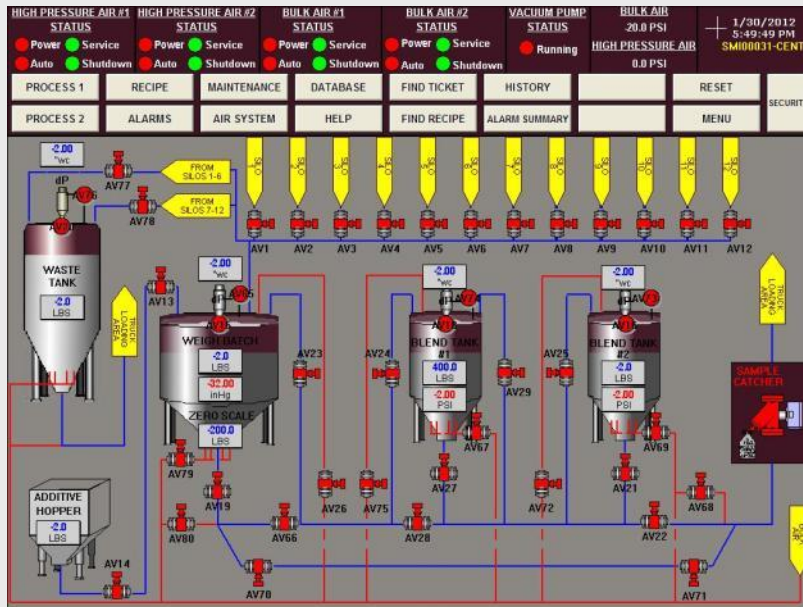

Operator Interface – Auto Batch

Smart-Iron Technologies™

In auto mode these two screens are used to write batch recipes. Pressing the “recipe” button on the main tool bar will bring up the recipe screen on the right. Selecting “load recipe” will bring up the spreadsheets for all previous batches (not shown). Selecting one will bring up the batch recipe screen on the left. You can run this batch recipe as is or make changes to it. Selecting the “create recipe” button from the recipe screen on the right brings up the batch recipe screen with blank fields. Key in your customer and job information, select the ingredients and quantities then select “insert recipe”. The recipe screen on the right appears again for proofing and you select “start batch” to initiate the process.

The Smart-Iron operating system allows you to run two batches simultaneously.

The screenshot shows a Microsoft Excel spreadsheet titled "Batch Recipe". It contains a table for "Main Ingredients" with columns for Silo (Silo 1 to Silo 12), LBS, and a description. Below this is a table for "Additives" with columns for quantity, description, and LBS. A "Sample Catcher" checkbox is also present. A callout box points to the "Insert Recipe" button with the text "Press to Insert New".

Silo	LBS	Description
Silo 1	LBS	200 Mesh Silica
Silo 2	LBS	Belite
Silo 3	LBS	Class H
Silo 4	LBS	Class H
Silo 5	LBS	
Silo 6	LBS	
Silo 7	LBS	S&P
Silo 8	LBS	Class A
Silo 9	LBS	Class A
Silo 10	LBS	Gel
Silo 11	LBS	Flyash
Silo 12	LBS	Flyash

Quantity	Description	LBS
1		LBS
2		LBS
3		LBS
4		LBS
5		LBS
6		LBS
7		LBS

Insert Silo Ingredients Here

Insert Additive Ingredients Here

The screenshot shows the "RECIPE" operator interface. It features a top status bar with various system indicators (Power, Service, Shutdown) for High Pressure Air #1, High Pressure Air #2, Bulk Air #1, Bulk Air #2, and Vacuum Pump. Below this is a navigation menu with buttons for SILOS, RECIPE, MAINTENANCE, DATABASE, FIND TICKET, HISTORY, SHIPPING TICKET, RESET, SECURITY, WEIGH / BLEND, ALARMS, AIR SYSTEM, HELP, FIND RECIPE, ALARM SUMMARY, REPORTS, and MENU. The main area is divided into two columns for "RECIPE 1" and "RECIPE 2". Each column has a table for "INGREDIENT" and "WEIGHT". A "START BATCH" button is located between the two columns. Below the tables are input fields for CUSTOMER, LOCATION, WELL NAME, and DEPTH. At the bottom, "TOTAL BATCH WEIGHT" is displayed as 0.0000 LBS for both recipes.

Operator Interface – Shipping Tickets

Smart-Iron Technologies™

Shipping tickets are automatically populated with the batch ingredients entered from the recipe screens. As a batch is loaded the shipping papers will appear on one of the monitors for review and editing if necessary before printing.

The shipping papers document is custom formatted to your preferences. Each shipping document is numbered and can be tracked or sorted in the system numerically or by any other information field.

The screenshot shows a control panel with the following elements:

- Status Indicators:** Four sets of indicators for High Pressure Air #1, #2, Bulk Air #1, and #2. Each set includes 'Power' (red), 'Service' (green), and 'Auto' (red) lights, along with 'Shutdown' (green) lights. A 'VACUUM PUMP' indicator shows 'Running' (red).
- System Information:** Date/Time: 8/3/2012 1:59:48 PM; User: VIN-THINK engineer.
- Navigation Menu:** Buttons for SILOS, RECIPE, MAINTENANCE, DATABASE, FIND TICKET, HISTORY, SHIPPING TICKET, RESET, SECURITY, WEIGH / BLEND, ALARMS, AIR SYSTEM, HELP, FIND RECIPE, ALARM SUMMARY, REPORTS, MENU.
- SHIPPING TICKETS Screen:**
 - PLC Clock: 01 - 01 - 0000, 00 : 00 : 00
 - Two columns for 'SHIPPING TICKET 1' and 'SHIPPING TICKET 2', each with 'INGREDIENT' and 'WEIGHT' headers.
 - Buttons for 'RESET RECIPE' on both sides.
 - Input fields for 'CUSTOMER', 'LOCATION', 'WELL NAME', and 'DEPTH' on both sides.
 - Total Batch Weight: 0 LBS for both tickets.

SHIPMENT NO.		CUSTOMER		DATE SHIPPED		REGISTRY NO.			
2301						PAGE 1 OF 1			
TRUCK NO. MOTOR VESSEL NAME		TRAILER NO.		JOB LOCATION (PLANT OR FIELD)		WELL NAME OR JOB NAME			
SPECIAL INSTRUCTIONS									
PLC AND/OR RECORDS INDEX		TRAILER		PORTABLE TANKS					
NO.	DOT SHIPPING DESCRIPTION (SHIPPING NAME, HAZARD CLASS, UN #, PACKAGE GROUP)	CHEMICAL NAME	WT. (LBS)	TYP. PACKAGE	NO. OF PACKAGES	UNIT	QUANTITY RETURNED		
		Class C	9440	TANK	1	PF-903			
		Calcium Chloride	188	TANK	1	PF-001			
		Class C	9520	TANK	1	PF-903			
UNIT			DESCRIPTION	WEIGHT	UNIT			DESCRIPTION	WEIGHT
					Total Weight			19148.00	LBS
THIS IS TO CERTIFY THAT THE ABOVE NAMED MATERIALS ARE PROPERLY CLASSIFIED, DESCRIBED, PACKAGED, MARKED AND LABELED AND ARE IN THE PROPER CONDITION FOR TRANSPORTATION ACCORDING TO THE APPLICABLE REGULATIONS OF THE U.S. DEPARTMENT OF TRANSPORTATION OR DELEGATED TO THE SATISFACTION OF THE CUSTOMER.									
							CERTIFIED BY (SIGNATURE)		

Training, Commissioning & Support

Smart-Iron Technologies™

Training begins when your plant arrives on-site. It is important that your bulk plant manager and one or two lead operators are involved in the assembly process. By observing the assembly process they will know where everything is and better understand how the process works. Once the installation is complete we spend the first week of operation on-site with you commissioning the plant. Training is accomplished while producing and selling product and insuring that your operators are proficient at running the plant.

Once our presence at the site is no longer necessary our continued support is provided by telephone and the internet. We can answer any question and address almost any condition.

For example, while talking to you on the phone we take over your monitor using VPN access software and show you how to correct a problem or change a set point. This support is available to you 24/7 and is free for your first year's operation. Subsequent years can be purchased at your option. We support all of our plants this way.

Here's what customers say:

“Our plant has been in operation for two and a half years. When we call for assistance or with a question or problem SMI's response is fast and professional. They do a good job supporting their products.”

Brian Watson
Bulk Plant Manager
Artesia, NM

Clean Dry Air Supply

Smart-Iron Technologies™

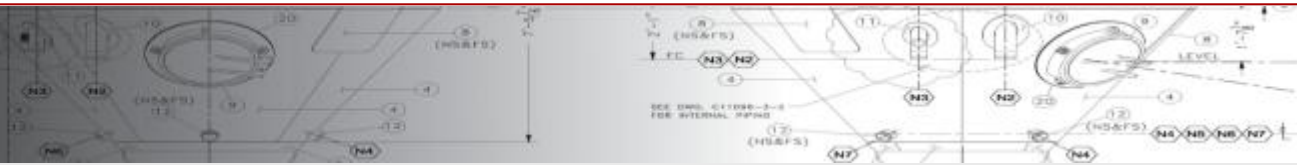

Air is the motive force in a cement bulk plant. There are three types used in a pressure/vacuum plant, **instrument air** (operates the butterfly valve actuators and pulses the dust collectors), **bulk air** (moves product through the blending process and out the truck or marine vessel) and **vacuum** (pulls batch ingredients from the silos and additive hopper to the weigh batcher).

The process requires three different types of air machines and because a bulk plant is dead in the water if any of them fail, SMI's Smart-Iron air package has 100% redundancy built in. Down time is eliminated.

Air compressors are designed to run at a given pressure and volume. In a cement bulk plant they have to sit at idle for long periods and then run at 100% capacity to fill a large vessel from 0 PSI to approximately 15 PSI or 15Hg. It's a rough service life and compressors tend to overheat in hot weather.

In the Smart-Iron air package each machine is designed to run at the specific pressure and volume required by the plant for optimum performance. The compressor room is insulated, sound attenuated and ventilated. Hot air from each machine's oil cooler is dumped outside. Fresh air is brought into and taken out of the compressor room by VFD controlled blowers to maintain temperature.

Each machine is protected from dusty air by a properly sized filtration system that is specifically rated to its requirements.

All compressors are controlled and monitored by the PLC. Maintenance bulletins and system alerts are displayed and recorded at the operator's console to insure required maintenance is performed.

Our air systems run reliably in hot desert environments with no overheat issues.

Compressor Screen

Smart-Iron Technologies™

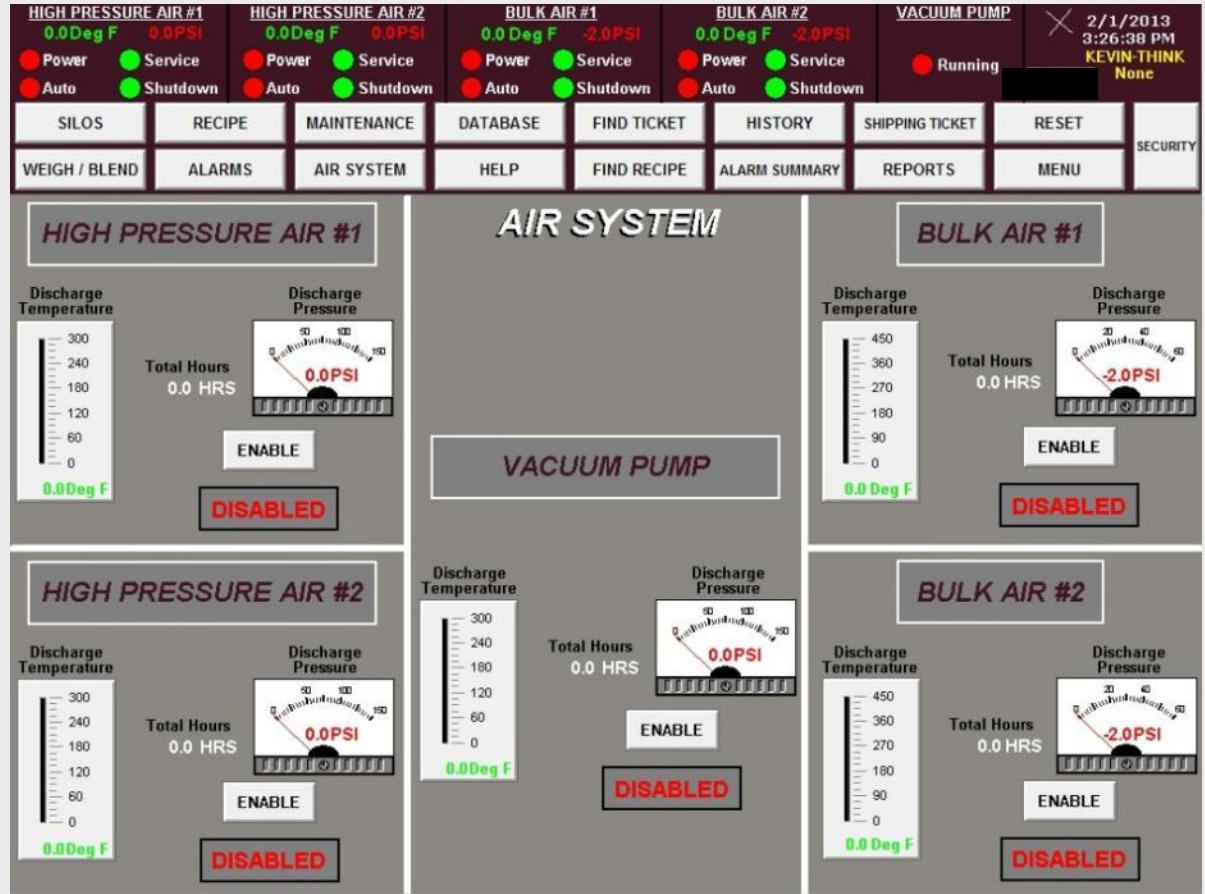

The air supply system is the single most expensive component in the plant.

In a Smart-Iron plant the air machines are controlled and monitored from the control console.

By selecting the “air system” button on the tool bar this screen will be displayed.

Air system status is displayed above the tool bar at all times.

System Integrity Testing

Smart-Iron Technologies™

In a cement bulk plants butterfly valves are used to direct the flow of material. All valves are subject to abrasive wear and have an operating life. To insure product quality and efficiency it is critical to know valve condition at all times.

System integrity testing is an automatic function performed by the Smart-Iron software. Selecting the “Integrity Test” button from the tool bar menu initiates the testing sequence. The sequence is a one hour comprehensive test resulting in a status and record of the test run.

Silo primary discharge valves are tested individually. Weigh batcher and blender valves are tested as a group. Leaking valves are identified and the severity of the leak is shown in CFM. This information is interpreted by the software and a report addressing necessary corrective actions is generated.

Smart-Iron software gathers and records the volume of material that passes through each valve and pipe section and compares it to the known wear rates for each location. With this information the software builds a report called “Valve Life” that is available for review at any time. It is displayed as a bar chart indicating the total life expectancy of each valve v/s its current condition.

Preventative Maintenance

Smart-Iron Technologies™

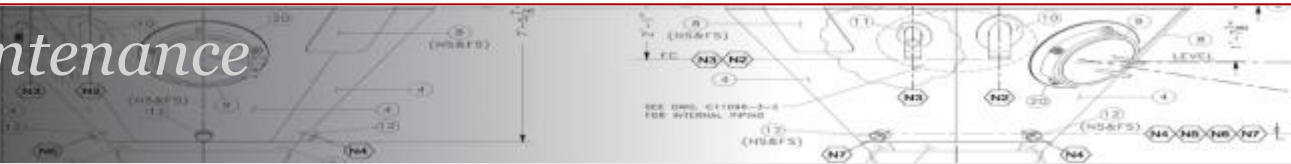

Maintenance schedules are programmed into your Smart-Iron software for all the major components of the plant. Routine service intervals for your compressors are set based on run time and will display on the screens in the control room and be recorded as service bulletins. Service bulletins can be postponed (by operators with security clearance) if plant demands dictate but will continue to reappear and be recorded until the scheduled maintenance is performed.

Compressor temperatures are monitored and will send alerts if set point values are exceeded. Alerts are recorded and can be used for analysis and trouble shooting. If temperatures reach high/high set points the machines will shut down until the condition is addressed.

Product flow is measured and recorded through each valve and pipe section. The valve life report can be programmed to give pop up service bulletins.

Differential pressure is measured across the filters in all dust collectors to indicate efficiency. Set points can be programmed from this information to give pop up service bulletins. This monitoring capability can make the difference in States where air permits are hard to get.

The Smart-Iron process uses visibility and accountability to promote a reliable preventative maintenance program.

All Things Considered

“A bulk plant is an investment. Our goal is to build a plant that makes your investment back quickly.”

Here are some ways we do this:

▪ **Reduce Labor Cost 30%**

➤ The optimal crew size to run a Smart-Iron plant is three properly trained personnel including the supervisor. In Auto mode one man can effectively run the plant when necessary.

▪ **Reduce Maintenance Cost 15%**

➤ Maintenance costs are significantly reduced by the preventative maintenance features built into our operating system. This savings is magnified when there are multiple plants running a standard process.

▪ **Reduce Production Cost 20%**

➤ Simply put, on a busy day no human operator can match the speed and accuracy of the Smart-Iron operating system. Process errors and the liability they cause are virtually eliminated.

These are major points but there are many ways Smart-Iron Technologies make you money. This state of the art technology is driven by a knowledgeable and experienced team of professionals who are dedicated to being the very best.

Our services include:

Plant Design
Manufacturing
Construction
Automation
Process Controls
Plant Assessments
Trouble Shooting
Upgrades
Expansions

Site Surveys
Facility Acquisition
Facility Design
Cost Analysis
Project Planning
Project Management
Permitting
Licensing

Leasing Programs

SMI Smart-Iron Technologies TM cement bulk plants can be leased in many circumstances, particularly in multiple plant strategic programs.

SMI leasing resources can be made available as an integral part of new facility construction.

Contact us at our offices in Franklin, Louisiana at (337) 836-9894 or call me directly at (337) 578-2086.

Thanks,
Benny Splane
Director of Sales and Marketing

